

21st European Conference on Fracture, ECF21, 20-24 June 2016, Catania, Italy

## Indicators of HSLA steel behavior under low cycle fatigue loading

V. Aleksić<sup>a</sup>, Lj. Milović<sup>b\*</sup>, B. Aleksić<sup>b</sup>, Abubkr M. Hemer<sup>b</sup>

<sup>a</sup>*Institute for testing of materials-IMS Institute, Bulevar vojvode Mišića 43, 11000 Belgrade, Serbia*

<sup>b</sup>*University of Belgrade, Faculty of Technology and Metallurgy, Karnegijeva 4, 11120 Belgrade, Serbia*

### Abstract

In present paper, the experimental research of the behaviour of high-strength low-alloy steel (HSLA) exposed to low-cycle fatigue (LCF) with controlled and fully reversible strain ( $\Delta\varepsilon/2 = \text{const}$ ,  $R_\varepsilon = \varepsilon_{\min}/\varepsilon_{\max} = -1$ ) has been analysed. Low-cycle fatigue tests were performed on a series of smooth specimens made of steel Nionikral 70 (NN-70), with semi-amplitude of controlled strain,  $\Delta\varepsilon/2=0.35, 0.45, 0.50, 0.60, 0.70$  and  $0.80$ . Characterization and description of the low-cycle elastoplastic behaviour of the material by construction of characteristic curves of low-cycle fatigue are made using the characteristic hysteresis, load-strain force for each level of controlled strain, selected from the areas of stabilization. For the selection of stabilized hysteresis and processing of the results of low-cycle fatigue tests the recommendations of the ISO 12106:2003 (E) and ASTM E 606-04 standards were used, which in this work means to compare the two results. For each strain level characteristic stabilized hysteresis were selected, determined in accordance with recommendations of the ISO 12106:2003 (E) and ASTM E 606-04 standards, from which the data necessary for further processing of the results and finally for the construction of characteristic curves of low-cycle fatigue were read. Constructed curves are compared, and the effect of selection of the recommendations from the standards on characterization of the behaviour of steel NN-70 estimated. The results of experimental investigation have given us important information on the understanding of fatigue behaviour of steel NN-70. In this work the results of static and dynamic, that is monotonous and fatigue behaviour of the material, were compared, which is a practical contribution to the assessment of the behaviour of steel NN-70 exposed to the effects of low-cycle fatigue, i.e. monotonous and fatigue behaviour of the material.

Copyright © 2016 The Authors. Published by Elsevier B.V. This is an open access article under the CC BY-NC-ND license (<http://creativecommons.org/licenses/by-nc-nd/4.0/>).

Peer-review under responsibility of the Scientific Committee of ECF21.

*Keywords:* LCF; HSLA; area of stabilization; stabilized hysteresis

### 1. Introduction

Most of the damages on the steel structures that lead to catastrophic fractures occur due to fatigue loads. The damages of fatigue nature represent between 50 and 90% of all damages over the life of the structure, thus representing an important structural problem. A large number of machines and plants during their exploitation life have a relatively small number of cycles that last for a long time: rotors of various turbojet engines, highly-strained parts of turbines, wave-stricken parts of ship structure, high-pressure vessels, piping, steam lines, gas pipelines, reactor plants and installations for the process, chemical and food industries, so that one can say that during their exploitation life they are exposed to the effects of variable load of the stop-start type, i.e. low-cycle fatigue. For low-cycle fatigue of materials, the values of variable load in critical areas exceed the value of the yield stress, i.e. after a relatively small number of cycles on these locations plastically strained zone begins to create. The fatigue

\* Corresponding author:

*E-mail address:* [acibulj@tmf.bg.ac.rs](mailto:acibulj@tmf.bg.ac.rs)

life of the elements of such steel structures can be assessed by analyzing the behaviour that includes processing of the data on load, geometry and selected material used for manufacture of the element or structure. Large contributions to this analysis provide the indicators of the material behaviour when affected by low-cycle fatigue.

## 2. Background and characteristics of steel NN-70

Base metal (BM) used to make the test specimens was a plate of the dimensions 45x205x353 mm made of low-alloyed high-strength steel NN-70 with properties shown in Fig. 1 and Tabs 1 and 2.

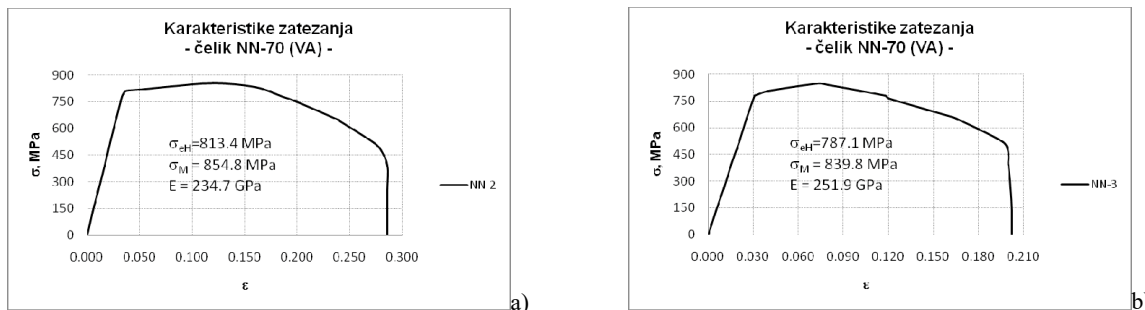

Fig. 1. Results of static testing of tensile properties of steel BM NN-70 [Aleksić (2016)]

Table 1. Chemical composition of NIONIKRAL 70, %wt [Aleksić (2016)]

C	Si	Mn	P	S	Cr	Ni	Mo	V	Al	As	Sn
0.106	0.209	0.220	0.005	0.0172	1.2575	2.361	0.305	0.052	0.007	0.017	0.014
Cu	Ti	Nb	Ca	B	Pb	W	Sb	Ta	Co	N	/
0.246	0.002	0.007	0.0003	0	0.0009	0.0109	0.007	0.0009	0.0189	0.0096	/

Table 2. Mechanical properties of NIONIKRAL 70 [Aleksić (2016)]

Property	BM
Ultimate tensile strength, MPa	854.8, Fig. 1a <b>855</b> , rounded value
Yield strength, MPa	813.4, Fig. 1a <b>815</b> , rounded value
Elastic modulus, GPa	234.7, static, Fig. 1a <b>221.4</b> , dynamic, LCF
Impact toughness, J	96.83, 20 °C <b>97</b> , rounded value, 20 °C
E initiation, J	39.60, 20 °C <b>40</b> , rounded value, 20 °C
E propagation, J	57.23, 20 °C <b>57</b> , rounded value, 20 °C
HV30	245-269, plate of BM <b>257</b> , mean value, plate of BM
HV10	252-262, stick for LCF specimen [Bulatović (2014)] <b>257</b> , mean value, specimen of LCF

Steel NN-70 is the Yugoslav version of American steel HY-100 and is intended for manufacture of ship structures, submarines and pressure vessels by welding, where the required toughness is extremely important. The technology of manufacture and thermomechanical processing (TMCP steels [Radović and Drobñak (2001)]) of the steel called Nionikral-70 is the result of joint research work of the metallurgists of Military Technical Institute in Žarkovo (VTI) and the steelworks "Jesenice" from Jesenice [Grabulov (1986)], in the early 90's of the last century. It was made in the electric furnace, cast in brams, subsequently rolled into slabs and then the sheets of various thicknesses. Due to some of its characteristics, it is classified among the fine-grained steels. The process of hardening is the combination of classical improvement (quenching and tempering) with grain refinement in accordance with selected chemical composition, by microalloying and appropriate deposition [Radović and Marković (1984)]. In determining the limit values of carbon and other alloying elements for the analysis, bearing in mind the purpose of the steel, care was taken to meet the requirements for the combination of characteristics such as strength, ductility, resistance to crack initiation and propagation, the stability of these properties at low temperatures, good resistance to fatigue and stress corrosion, good workability and weldability [Radović and Marković (1984)]. Steel NN-70 is intended to be shaped by welding, so that after it was successfully mastered, its suitability for welding was also subjected to assessment [Grabulov (1986)].

### 3. Testing of steel NN-70 at low-cycle fatigue

From the necessity to assess the low-cycle fatigue life, and in order to determine the fatigue characteristics of the material, the test of resistance of the base metal (BM) of steel NN-70 to low-cycle fatigue was carried out. Preparation of the test of resistance of steel NN-70 to low-cycle fatigue consisted of making smooth cylindrical specimens, Fig. 2 item 1, and tool for placing the specimens in the tearing-machine jaw, Fig. 2 items 2 and 3, and check of the target static tensile properties of steel NN-70, Fig. 1.

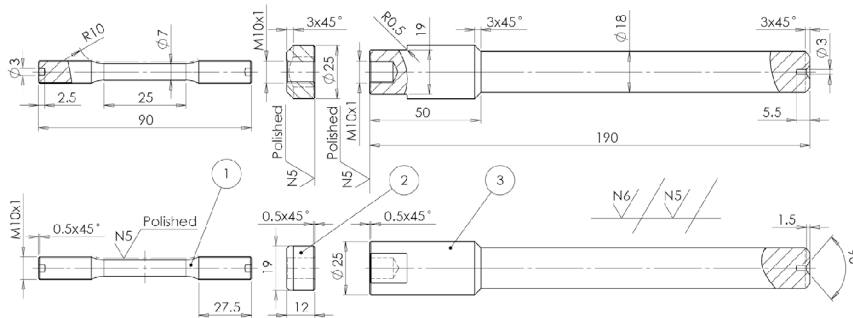

item 1, LCF specimen, NN-70, D=7 mm; item 2, Jam nut, 42CrMo4; item 3, Grip holder, 42CrMo4.

Fig. 2. Specimen and specimen holder for testing LCF of steel NN-70 [Aleksić (2016)]

The procedure for determination of the low-cycle fatigue characteristics and geometry of cylindrical smooth specimen as well, Fig. 2 item 1, are defined by the ISO 12106:2003(E) (2003) and ASTM E 606-04° (2004) standards.

Fatigue test was conducted on a universal MTS system (Material Testing System - Universal hydraulic dynamic tearing machine of 500 kN) for the material testing, schematically presented by photos in Fig. 3.

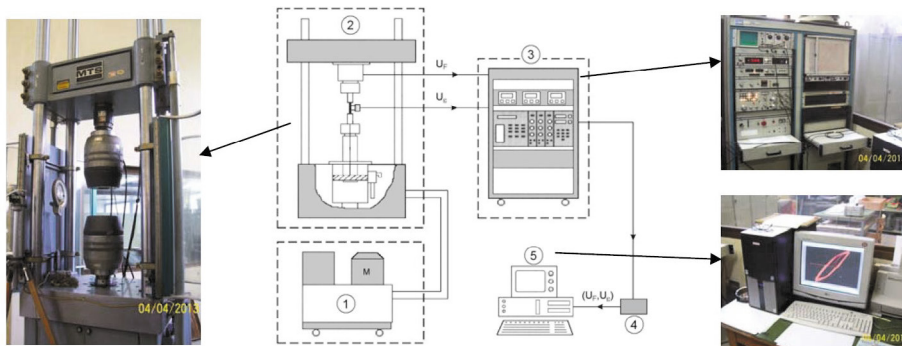
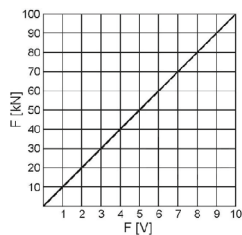
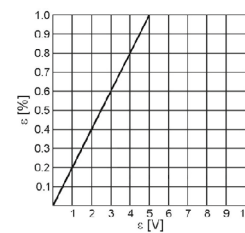

Fig. 3. MTS universal system for the material testing, 1 – Hydraulic aggregate, 2 – Pulsating device, 3 – Control system, 4 – A/D converter, 5 - PC

Linear characteristics of used MTS force-feeding device, Fig. 4a, and MTS extensometer with measuring length of  $L_0=25$  mm, Fig. 4b, are graphically presented in Fig. 4.



a) MTS force feeding device,  $F[kN] = F[V] \cdot 10$



b) MTS extensometer,  $\epsilon[\%] = \epsilon[V] \cdot 0.2$

Fig. 4. Linear characteristics of MTS force-feeding device and MTS extensometer

Low-cycle fatigue tests were performed on a series of smooth specimens made of steel NN-70, with semi-amplitudes of controlled and fully reversible strains,  $\Delta\epsilon/2=0.35, 0.45, 0.50, 0.60, 0.70$  and  $0.80$  ( $\Delta\epsilon/2 = \text{const}$ ,  $R_\epsilon = \epsilon_{\min}/\epsilon_{\max} = -1$ ).

#### 4. Processing and presentation of test results

As a result of low-cycle fatigue test on one specimen (one amplitude level of strain) there is a record in the program EXCEL which, using the tools available in EXCEL, can be further processed according to our requirements [Aleksić (2016)].

Before processing of the results it is possible to roughly determine the cycle in which there is a significant drop of force,  $N_{\text{assessment}}$ . To determine the indicators of low-cycle fatigue of the material presented by cyclic stress-strain curve (CSSC) and basic curve of low-cycle fatigue (BCLCF), the following analyses of the results of low-cycle fatigue tests were made:

1. Elastic modulus from  $N_{1/4}$  cycle were determined.
2. For each amplitude level of strain (each specimen), by filtering the data, extreme values of the load forces and number of cycles were paired, and thus we eliminated the excess data. Both positive and negative values of the load forces were filtered.
3. The diagrams of extreme values of the load forces and number of cycles (F-N curves) were drawn for each amplitude level of strain.
4. The diagrams of determination of the areas of stabilization were drawn (positive part of the F-N curves, the area of stabilization, was determined by linearization of the data on maximum tensile forces of load in low-cycle fatigue tests for each amplitude level of strain). The areas of low-cycle fatigue and characteristic hysteresis were defined after the following:
  - a. Determination of maximum force and starting cycle  $N_{\text{start}}$ ,
  - b. Determination of the cycle of start of stabilization,  $N_{\text{ss}}$ , end of stabilization,  $N_{\text{es}}$ , and area of stabilization,
  - c. Determination of the cycle  $N_{F-25\%}$ , force drop by 25% [ISO 12106:2003(E) (2003)],
  - d. Determination of the cycle  $N_{F-50\%}$ , force drop by 50% [ASTM E 606-80 (1985)],
  - e. Determination of the cycle  $N_{-100\%}$ , force drop to  $F=0$ , and  $N_{\text{end}}$ , cycle of test end.
5. The characteristic data of stabilized hysteresis curves for each amplitude level of strain were defined:
  - a. Extreme values of load force  $F_{\text{max}}$  and  $F_{\text{min}}$  were read.
  - b. The spots of intersection of the hysteresis curve and positive part of strain axis were established in EXCEL (coefficients of the straight line,  $m$  and  $b$  [Aleksić (2016)] were determined). This can be done graphically [Bulatović (2014)], too, in some of the programmes for precision drawing.
  - c.  $\Delta\varepsilon_p/2$ ,  $\Delta\varepsilon_e/2$ ,  $A_0=D^2 \cdot \pi/4$ ,  $F_{\text{mean}}=(|F_{\text{smak}}| + |F_{\text{smin}}|)/2$  i  $\Delta\sigma/2=F_{\text{mean}}/A_0 \cdot 1000$  values were calculated.
6. The data on all amplitude levels of strain were classified, cyclic stress-strain curves and basic curves of low-cycle fatigue were constructed and cyclic vs. monotonous stress-strain curves compared:
  - a. The exponents and coefficients were determined using linearized step function,  $n'$  and  $K'$ , Tab. 3, Figs. 5a and 6a.
  - b. The exponents and coefficients were determined using linearized elastic component,  $b$  and  $\sigma'_f$ , Tab. 4, Figs. 9a and 10a.
  - c. The exponents and coefficients of linearized plastic component,  $c$  and  $\varepsilon'_f$ , were determined, Tab. 5, Figs. 9b and 10b.
7. The data on cyclically stress-strain curves, Figs. 5b and 6b, and basic curves of low-cycle fatigue, Figs. 11b and 12b, were classified for the group of selected stabilized hysteresis,  $N_{s1}$  and  $N_{s2}$ , in order to construct them [Aleksić (2016)], and finally,
8. Transition life was determined for a group of selected stabilized hysteresis,  $N_{s1}$  and  $N_{s2}$ , Tab. 6 [Aleksić (2016)].

#### 5. Analysis and comparison of the results

Based on experimental data, the linearized step functions, Fig. 5a (for  $N_{s1}$ ) and Fig. 6a (for  $N_{s2}$ ) were determined, and from them the exponents and coefficients necessary for the construction of the CSSC, Fig. 5b (for  $N_{s1}$ ) and Fig. 6b (for  $N_{s2}$ ). In Tab. 3, classified exponents and coefficients of the equation CSSC are shown for all selected stabilized hysteresis of steel NN-70. One can observe that for BM of steel NN-70 the exponent  $n'$  ranges in an interval from 0.045 to 0.047, and the coefficient  $K'$  in an interval from 937.6 to 946.2 MPa. In Fig. 7 (for  $N_{s1}$ ) and Fig. 8 (for  $N_{s2}$ ) a comparison of cyclic and monotonous stress-strain curves is presented, indicating good agreement between these curves, i.e. that BM of steel NN-70 exposed to low-cycle fatigue shows neither weakening nor hardening [Aleksić (2016)].

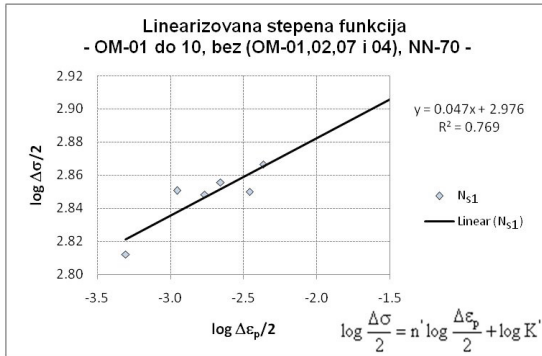

a) Exponent  $n' = 0.047$  and coefficient  $\log K' = 2.976$  of cyclically stress-strain curve

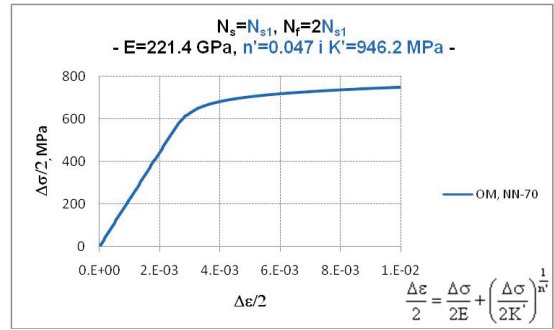

b) Cyclic stress-strain curve

Fig. 5. Construction of CSSC for BM of NN-70,  $N_f = N_{f1}$  (force drop by 25%, ISO 12106:2003(E) (2003))

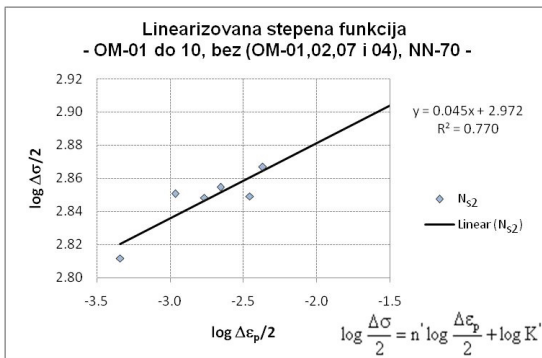

a) Exponent  $n' = 0.045$  and coefficient  $\log K' = 2.972$  of cyclically stress-strain curve

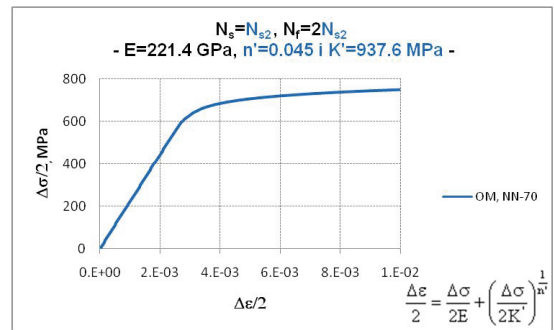

b) Cyclic stress-strain curve

Fig. 6. Construction of CSSC for BM of NN-70,  $N_f = N_{f2}$  (force drop by 50%, ASTM E 606-80 (1985))

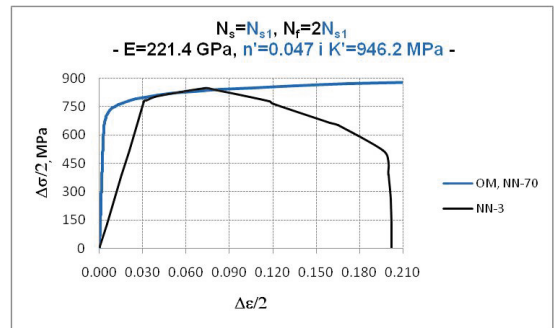
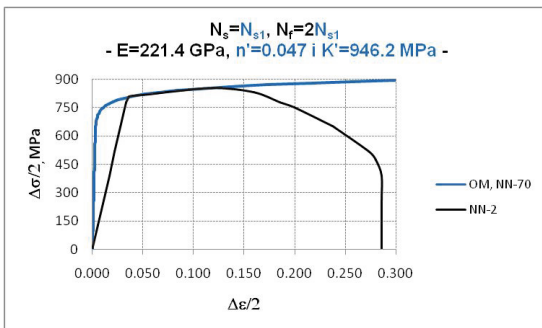

Fig. 7. Comparison of cyclic and monotonous stress-strain curve of BM of NN-70 steel,  $N_f = N_{f1}$  (force drop by 25%, ISO 12106:2003(E) (2003))

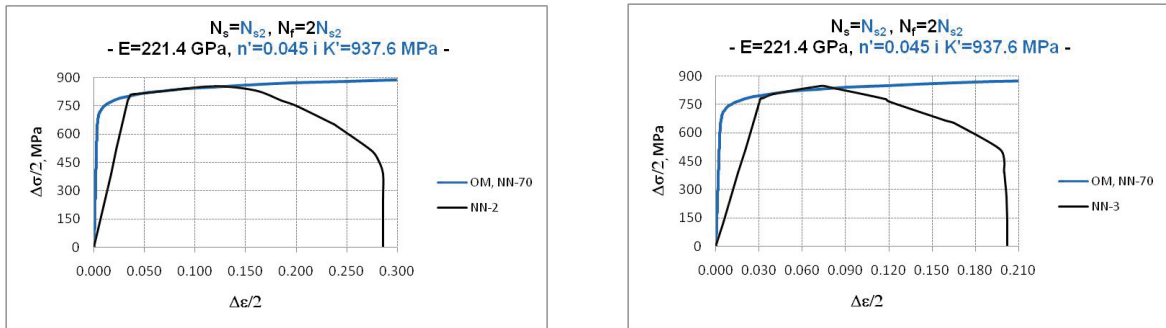

Fig. 8. Comparison of cyclic and monotonous stress-strain curve of BM of NN-70 steel,  $N_f = N_{f2}$  (force drop by 50% [ASTM E 606-04e (2004)])

Table 3. Exponents  $n'$  and coefficients  $K'$  of cyclic stress-strain curves

BM NN-70	$N_f$	$N_s$	$n'$	$\log K'$	$K', \text{MPa}$
$N_{s1} = N_{f-25\%}/2$	$N_{f-25\%} = N_{f1}$	$N_{s1}$	<b>0.047</b>	2.976	<b>946.2</b>
$N_{s2} = N_{f-50\%}/2$	$N_{f-50\%} = N_{f2}$	$N_{s2}$	<b>0.045</b>	2.972	<b>937.6</b>

Linearized step function	$\log \frac{\Delta\sigma}{2} = n' \log \frac{\Delta\varepsilon_p}{2} + \log K'$
Cyclic stress-strain curve	$\Delta\varepsilon = \frac{\Delta\sigma}{E} + 2 \left( \frac{\Delta\sigma}{2K'} \right)^{\frac{1}{n'}}$

In Fig. 9a (for  $N_{s1}$ ) and Fig. 10a (for  $N_{s2}$ ) the linearized elastic components of the total-strain amplitude and in Fig. 9b (for  $N_{s1}$ ) and Fig. 10b (for  $N_{s2}$ ) linearized plastic components of the total-strain amplitude determined on the basis of experimental data are shown, in order to determine the exponents and coefficients required for construction of BCLCF. [Aleksić (2016)]

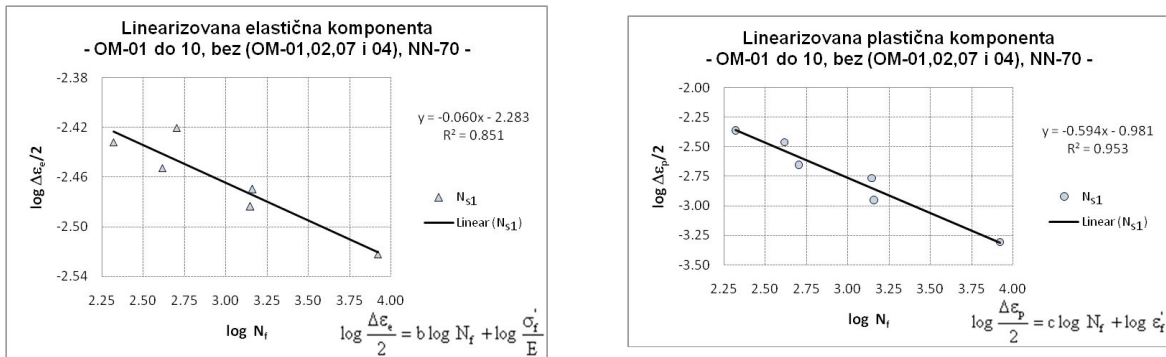

a) Exponent  $b = -0.060$  and coefficient  $\log \sigma_f'/E = -2.283$  of basic curve of low-cycle fatigue

b) Exponent  $c = -0.594$  and coefficient  $\log \varepsilon_f' = -0.981$  of basic curve of low-cycle fatigue

Fig. 9. Linearized components of total-strain amplitude, BM of NN-70,  $N_f = N_{f1}$  (force drop by 25%, ISO 12106:2003(E) (2003))

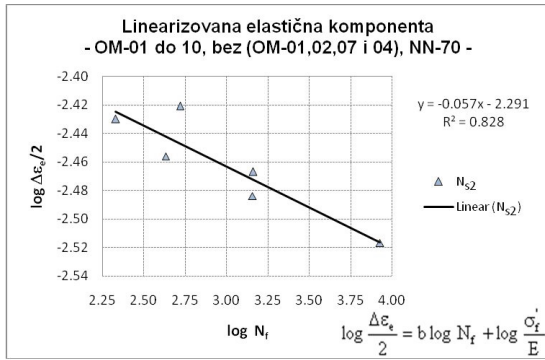

a) Exponent **b = -0.057** and coefficient  $\log \sigma'_f/E = -2.291$  of basic curve of low-cycle fatigue

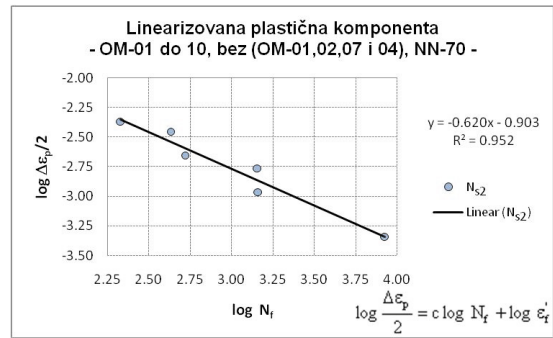

b) Exponent **c = -0.620** and coefficient  $\log \epsilon'_f = -0.903$  of basic curve of low-cycle fatigue

Fig. 10. Linearized components of total-strain amplitude, BM of NN-70,  $N_f = N_{f2}$  (force drop by 50%, ASTM E606-80 (1985))

Classified exponents and coefficients of elastic component of the total-strain amplitude of BCLCF equation for all selected stabilized hysteresis of steel NN-70 are shown in Tab. 4. One can observe that for BM of steel NN-70 exponent b ranges in an interval from -0.057 to 0.060, and coefficient  $\sigma'_f$  in an interval from 1132.7 to 1153.8 MPa. [Aleksić (2016)].

Table 4. Exponents **b** and coefficients  $\sigma'_f$  of elastic component of basic LCF curves

BM				$E_{mean0}$ , MPa	$E_{mean1}$ , MPa	$E = E_{mean}$ , MPa			
NN-70				223328	219427	221378			
	$N_f$	$N_s$	<b>b</b>	$\log \sigma'_f/E$	$\sigma'_f/E$	$\sigma'_{f0}$	$\sigma'_{f1}$	$\sigma'_f$	
	$N_{s1} = N_{f25\%}/2$	$N_{f25\%} = N_{f1}$	$N_{s1}$	-0.060	-2.283	0.0052	1164.0	1143.6	1153.8
	$N_{s2} = N_{f50\%}/2$	$N_{f50\%} = N_{f2}$	$N_{s2}$	-0.057	-2.291	0.0051	1142.7	1122.8	1132.7
Linearized part of elastic component			$\log \frac{\Delta \epsilon_c}{2} = b \log N_f + \log \frac{\sigma'_f}{E}$						
Basic curve of low-cycle fatigue			$\frac{\Delta \epsilon}{2} = \frac{\sigma'_f}{E} N_f^b + \epsilon'_f N_f^c$						

Classified exponents and coefficients of plastic component of the total-strain amplitude of BCLCF equation for all selected stabilized hysteresis of steel NN-70 are shown in Tab. 5. One can observe that for BM of steel NN-70 exponent c ranges in an interval from -0.594 to -0.620, and coefficient  $\epsilon'_f$  in an interval from 0.1045 to 0.1250. In Fig. 11a (for  $N_{s1}$ ) and Fig. 12a (for  $N_{s2}$ ) the relationship between  $\sigma_{max}$  and  $\Delta\sigma/2$  is shown for all strain levels, from which one can observe that the linear dependences  $\sigma_{max}-N_f$  and  $\Delta\sigma/2-N_f$  intersect in certain cycle  $N_f$ . BCLCF defined through appropriate stabilized hysteresis, with finite transition life  $N_{fT}$ , are shown in Fig. 11b (for  $N_{s1}$ ) and Fig. 12b (for  $N_{s2}$ ). [Aleksić (2016)]

Table 5. Exponents **c** and coefficients  $\epsilon'_f$  of plastic component of basic LCF curves

BM				$\log \epsilon'_f$	$\epsilon'_f$	
NN-70	$N_f$	$N_s$	<b>c</b>			
	$N_{s1} = N_{f25\%}/2$	$N_{f25\%} = N_{f1}$	$N_{s1}$	-0.594	-0.981	0.1045
	$N_{s2} = N_{f50\%}/2$	$N_{f50\%} = N_{f2}$	$N_{s2}$	-0.620	-0.903	0.1250
Linearized part of plastic component			$\log \frac{\Delta \epsilon_p}{2} = c \log N_f + \log \epsilon'_f$			
Basic curve of low-cycle fatigue			$\frac{\Delta \epsilon}{2} = \frac{\sigma'_f}{E} N_f^b + \epsilon'_f N_f^c$			



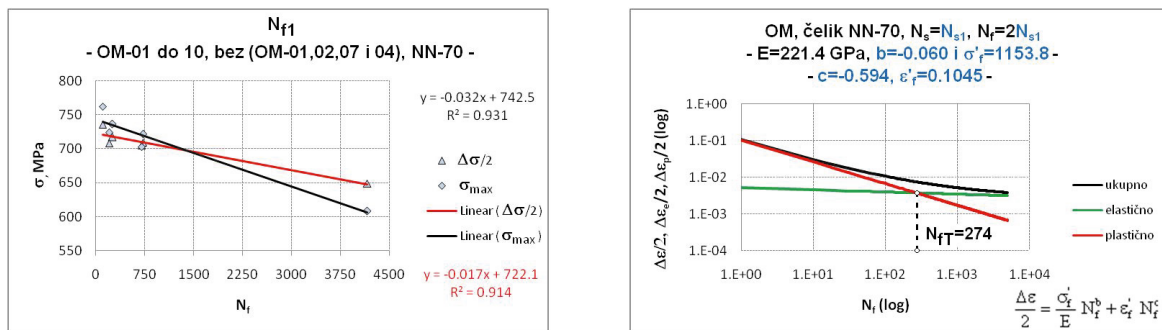

a) Ratio  $\sigma_{max}$  and  $\Delta\sigma/2$  for strain level  $\Delta\epsilon/2=0.35$  to  $0.80$

b) Basic curve of low-cycle fatigue

Fig. 11. Construction of BCNCF, BM of NN-70,  $N_f = N_{f1}$  (force drop by 25%, ISO 12106:2003(E) (2003))

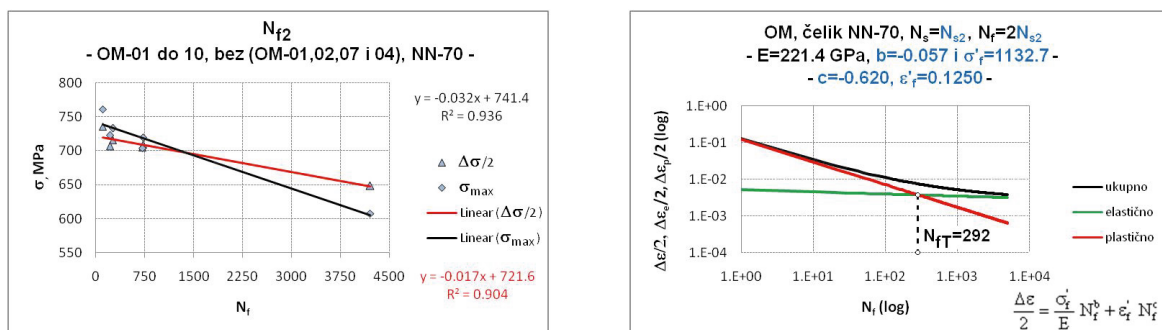

f) Ratio  $\sigma_{max}$  and  $\Delta\sigma/2$  for strain level  $\Delta\epsilon/2=0.35$  to  $0.80$

g) Basic curve of low-cycle fatigue

Fig. 12. Construction of BCNCF, BM of NN-70,  $N_f = N_{f2}$  (force drop by 50%, ASTM E606-80 (1985))

In Tab. 6 the transition life of steel NN-70 was calculated on the basis of the parameters determined according to the methods for determination of the stabilized hysteresis from two standards [ISO 12106:2003(E) (2003), ASTM E606-80 (1985)].

Transition life,  $N_{fT}$ , for BM of steel NN-70 ranges in an interval from 274 to 292, i.e. transition life determined according to the standard ISO 12106: 2003 (E) (2003) is about 6% lower than the transition life calculated based on the methodology for determination of stabilized hysteresis according to the ASTM E 606-04 standard [ASTM E606-80 (1985), Aleksić (2016)]

Table 6. Transition life of BM of steel NN-70

BM	E, MPa	221378	elastic part		plastic part		
NN-70	$N_f$	$N_s$	<b>b</b>	<b><math>\sigma'_r</math></b>	<b>c</b>	<b><math>\epsilon'_r</math></b>	<b><math>N_{fT}</math></b>
$N_{s1} = N_{f,25\%}/2$	$N_{f,25\%} = N_{f1}$	$N_{s1}$	<b>-0.060</b>	<b>1153.8</b>	<b>-0.594</b>	<b>0.1045</b>	<u>274</u>
$N_{s2} = N_{f,50\%}/2$	$N_{f,50\%} = N_{f2}$	$N_{s2}$	<b>-0.057</b>	<b>1132.7</b>	<b>-0.620</b>	<b>0.1250</b>	<u>292</u>

Transition life

$$N_{fT} = \left( \frac{\epsilon'_r \cdot E}{\sigma'_r} \right)^{\frac{1}{b-c}}$$

## 6. Conclusion

The theoretical, experimental and numerical research of the behaviour of low-alloy high-strength steels exposed to loading induced by low-cycle fatigue that are described in this paper are very complex research task. Extensive theoretical studies have required synthesis of knowledge in multiple engineering fields and disciplines, and numerical and experimental studies are an important part of this work. Detailed analysis of the historical review of research in this area and analysis of the latest published



results as well have provided the base for further research in the field of low-cycle fatigue. One of the goals of the research imposed itself during the processing of the results of experimental investigations, and is expressed through improvement of the methodology and methods of processing of the test results in order to establish a universal methodology for assessment of the behaviour of materials affected by low-cycle load.

Through the analysis of the existing results the need arises for further research and the establishment of new universal principles regarding the accuracy of determination and calculation of the parameters, using various computer applications describing the behaviour of materials either directly or indirectly.

From certain characteristic stabilized hysteresis, based on default criteria, the data necessary to determine the equations of the characteristic curves of low-cycle fatigue were collected from which one can see the difference between the values of exponents and coefficients determined by presented methodology depending on the method applied for determination of stabilized hysteresis.

The new methodology for determination of the area of stabilized hysteresis and the possibility to select stabilized hysteresis for default criterion opens up new perspectives for future research. This applies to use in low-cycle fatigue tests of other materials with default criterion for determination of stabilized hysteresis in different operating conditions.

As one of the most interesting and promising directions for future research, the application of the developed methodology imposes itself in order to define the size of a fatigue crack as the main parameter for characterization of the existence of fatigue under conditions of variable load for as quality as possible determination of fatigue life and assessment of a material resistance to crack initiation, the propagation of which can be traced to its critical size by NDT methods.

The results obtained represent practical contribution to estimation of the behaviour of low-alloy high-strength steel NN-70 exposed to the effects of low-cycle fatigue.

## Acknowledgements

This work is a contribution to the Ministry of Education and Science of the Republic of Serbia funded Project TR 35011.

## References

- Aleksić V., 2016, Low cycle fatigue of high strength low alloy steels, The draft version of the doctoral dissertation reported on the Serbian, University of Belgrade, Faculty of Technology and Metallurgy, Belgrade.
- Bulatović S., 2014, Elastic-plastic behaviour of welded Joint of high strength low alloy in conditions of low cycle fatigue, Doctoral dissertation on the Serbian, University of Belgrade, Faculty of Mechanical Engineering, Belgrade
- Radović N., Drobnjak Đ., 2001, Development of steels for fabrication on welded constructions with improved safety, *Welding and Welded Structures*, vol.46, No.3, p. 81-92.
- Grabulov V., 1986, A contribution to the assessment of chemical composition and plate thickness influence on crack initiation in welded joints made of Nionikral 70 steel, Master thesis on the Serbian, University of Belgrade, Faculty of Technology and Metallurgy, Belgrade.
- Radović A., Marković D., 1984, The conquest of shipbuilding steel of high strength -NIONIKRAL-70, The report in Serbian, Military Technical Institute, Belgrade.
- ISO 12106:2003(E), *Metallic materials-fatigue testing-axial-strain-controlled method*, Geneva: ISO 2003, Switzerland.
- ASTM E606-80: *Standard Recommended Practice for Constant Amplitude Low Cycle Fatigue Testing*, ASTM Designation E606-80, Annual Book of ASTM Standards 1985, Vol. 03.01, p. 681.